

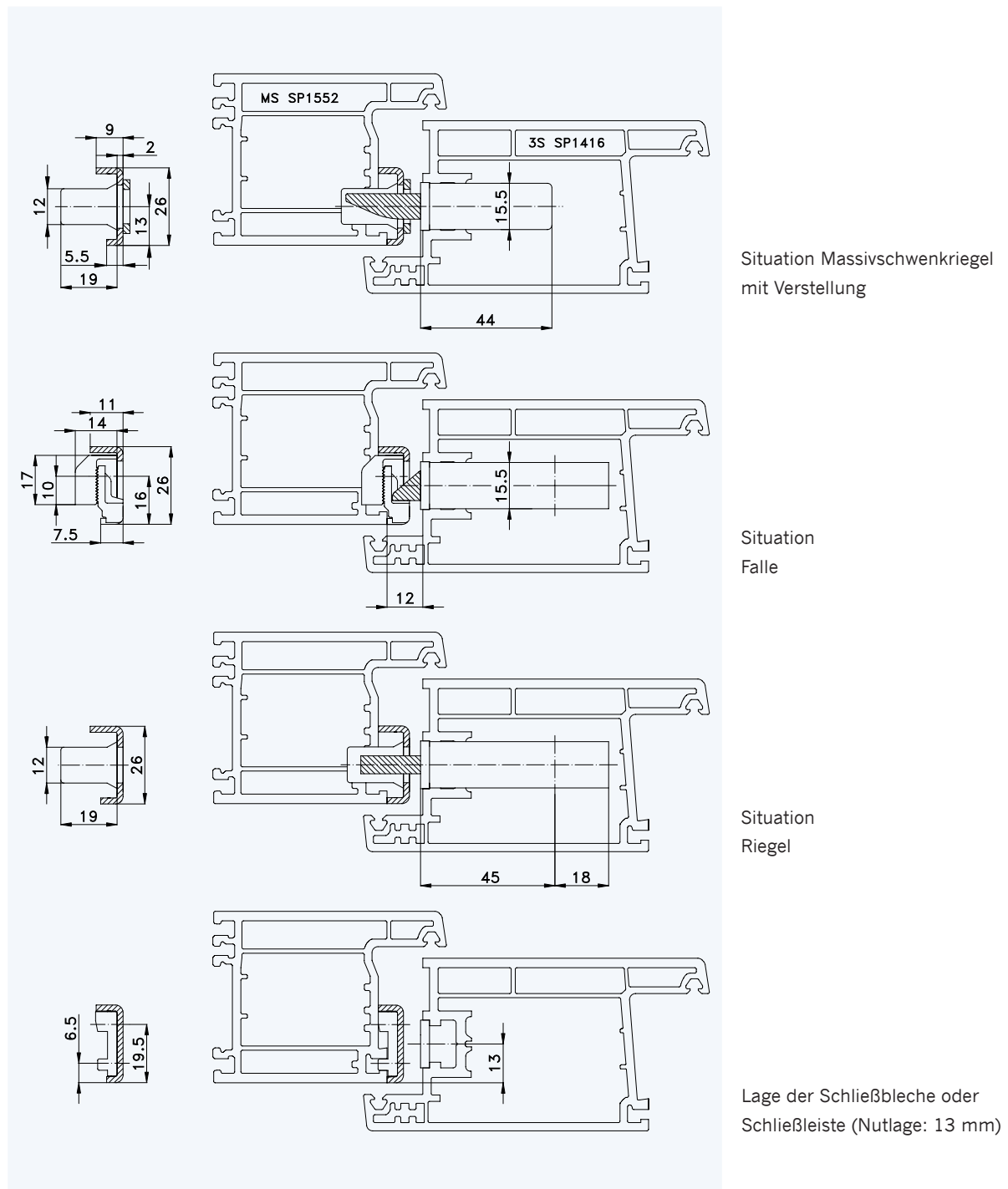

Profil „Magnor Solit“ Rahmen MS SP 1552; Flügel 3S SP 1416

Standard-Einbausituationen STV... F1660/45 92/... M...
mit Massivschwenkriegeln und Rahmenteilen U26-76





1 Profil „Magnor Solit“

2 Rahmen MS SP 1552; Flügel 3S SP 1416

3 Einbausituationen STV... F1660/45 92/... M...
mit Massivschwenkriegeln und Rahmenteilern U26-76

4

5

6

7

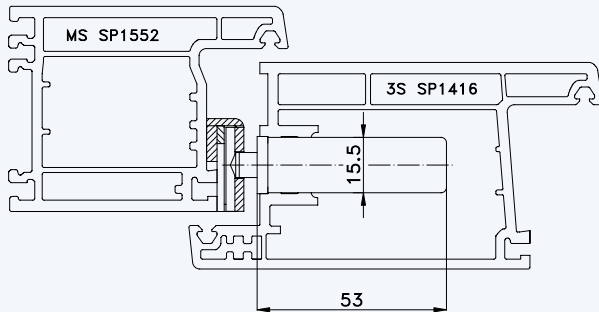
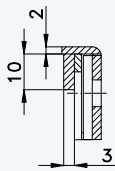

Situation Türfänger
(bei Verriegelung mit Türwächter)

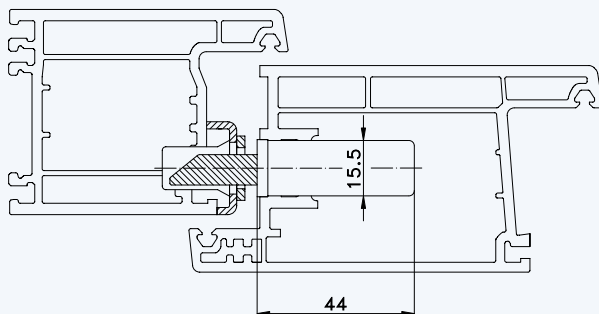
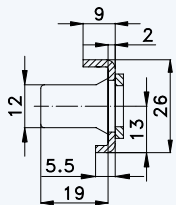

Situation Massivschwenkriegel
(bei Automatik-Verriegelung)

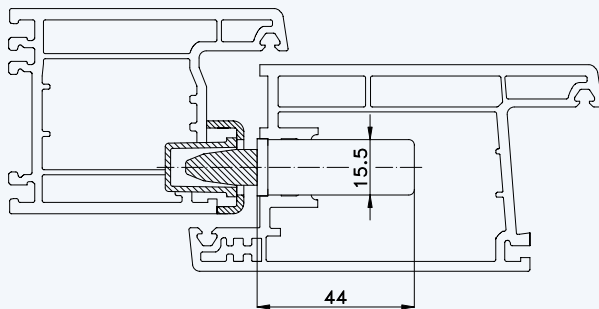
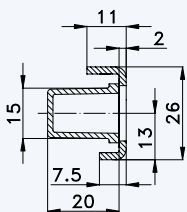

Situation Bolzen
(bei Bolzen-Verriegelung)

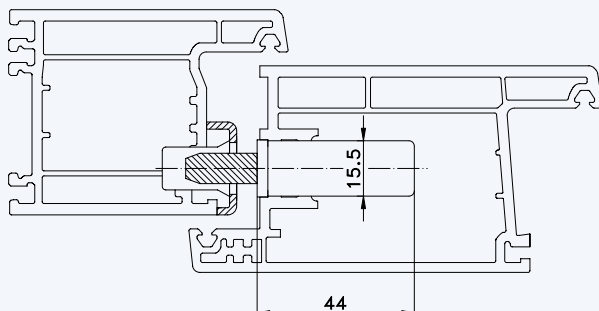
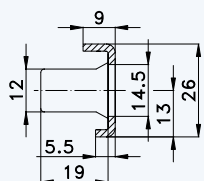

Situation Bolzen
(bei Tresor-Bolzen-Verriegelung)